

SPECIAL ORDER ONLY

MODEL	COLOR	SIZE	WEIGHT PER FOOT	AMP	TYPE	LENGTH
2601-2702-B	BLACK	10/4 (10 AWG Stranded Wire / 4 Conductors)	0.33 LBS / 0.15 Kg	25 MAX. PER CONDUCTOR	SEOOW*	SOLD BY THE FOOT
2601-2702-Y	YELLOW					
2601-2703-B	BLACK	8/4 (8 AWG Stranded Wire / 4 Conductors)	0.38 LBS / 0.17 Kg	35 MAX. PER CONDUCTOR		
2601-2703-Y	YELLOW					

*600 V PORTABLE OIL- AND WATER-RESISTANT OUTDOOR FLEXIBLE POWER CABLE.

SPECIAL ORDER ONLY

MODEL 2601-6273

SPLICE KIT, UF CABLE
Direct Burial

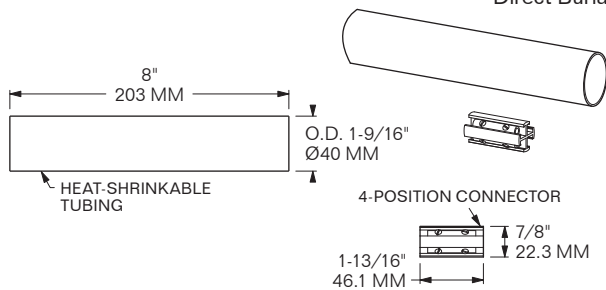

RATING: 14/3 TO 8/3 w/ GROUND, 600 V
MATERIAL: HEAT-SHRINKABLE TUBING
WEIGHT: 0.17 LBS / 0.08 Kg

MODEL 2601-7415

INTERIOR ASSEMBLY
Female

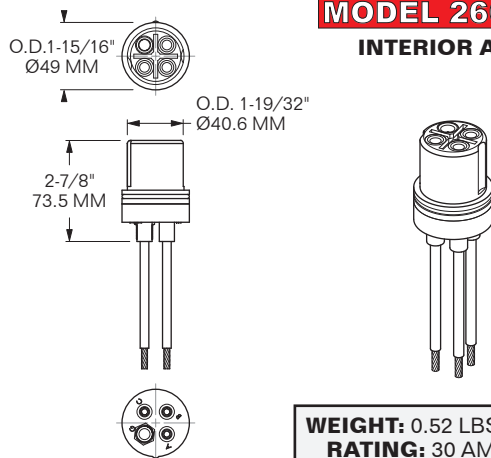

MODEL 2601-6270-NL

NO LID

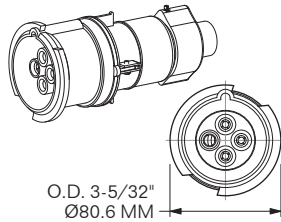

O.D. 3-5/32"
Ø80.6 MM

MODEL 2601-6270

FEMALE CONNECTOR

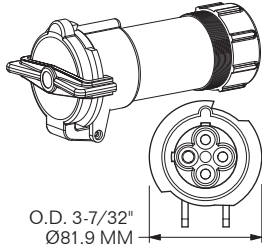

O.D. 3-7/32"
Ø81.9 MM

WORKS WITH: 2601-6274 MALE PLUG
HOUSING MATERIAL: POLYAMIDE w/ UV INHIBITORS
SLEEVE & TERMINAL SCREWS MATERIAL: BRASS
LOCKING CLIPS & SCREWS MATERIAL: STAINLESS STEEL
WEIGHT: 1.07 LBS / 0.48 Kg
RATING: 32 AMP, 440/480 V **REF. #:** 1900-01P

MODEL 2601-6274

MALE PLUG

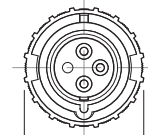
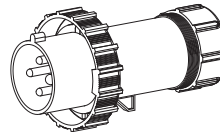

O.D. 3-21/32"
Ø92.9 MM

WORKS WITH: 2601-6270 FEMALE CONNECTOR
HOUSING MATERIAL: POLYAMIDE w/ UV INHIBITORS
PINS & TERMINAL SCREWS MATERIAL: BRASS
LOCKING CLIPS & SCREWS MATERIAL: STAINLESS STEEL
WEIGHT: 0.89 LBS / 0.4 Kg
RATING: 32 AMP, 440/480 V **REF. #:** 1800-03P1A

MODEL 2601-7416

FEMALE CONNECTOR

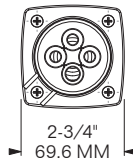
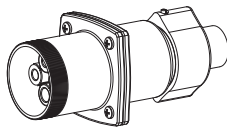

2-3/4"
69.6 MM

WORKS WITH: 2601-7417 MALE PLUG
HOUSING MATERIAL: POLYAMIDE w/ UV INHIBITORS
PINS & TERMINAL SCREWS MATERIAL: BRASS
WEIGHT: 0.66 LBS / 0.3 Kg **RATING:** 50 AMP, 250 V
REF. #: 1900-04P

SPECIAL ORDER ONLY

MODEL 2601-7417

MALE PLUG

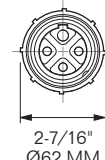
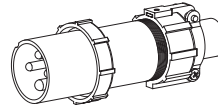

2-7/16"
Ø62 MM

WORKS WITH: 2601-7416 FEMALE CONNECTOR
HOUSING MATERIAL: POLYAMIDE w/ UV INHIBITORS
PINS & TERMINAL SCREWS MATERIAL: BRASS
WEIGHT: 0.68 LBS / 0.31 Kg **RATING:** 50 AMP, 250 V
REF. #: 1800-06P

SPECIAL ORDER ONLY

MODEL 2601-7418

FEMALE CONNECTOR

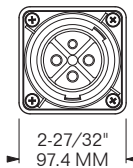
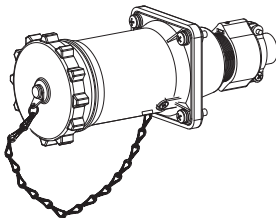

2-27/32"
97.4 MM

WORKS WITH: 2601-7419 MALE PLUG
HOUSING MATERIAL: POLYAMIDE w/ UV INHIBITORS
PINS & TERMINAL SCREWS MATERIAL: BRASS
LOCKING CLIPS & SCREWS MATERIAL: STAINLESS STEEL
WEIGHT: 1.97 LBS / 0.89 Kg
RATING: 60 AMP, 240 V **REF. #:** 1900-02P

SPECIAL ORDER ONLY

MODEL 2601-7419

MALE PLUG

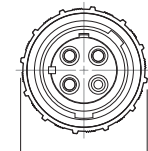
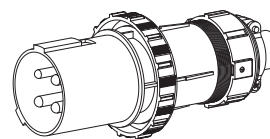

O.D. 3-21/32"
Ø92.9 MM

WORKS WITH: 2601-7418 FEMALE CONNECTOR
HOUSING MATERIAL: POLYAMIDE w/ UV INHIBITORS
PINS & TERMINAL SCREWS MATERIAL: BRASS
LOCKING CLIPS & SCREWS MATERIAL: STAINLESS STEEL
WEIGHT: 1.18 LBS / 0.53 Kg
RATING: 60 AMP, 240 V **REF. #:** 1800-04P