

MODEL 1212-6439

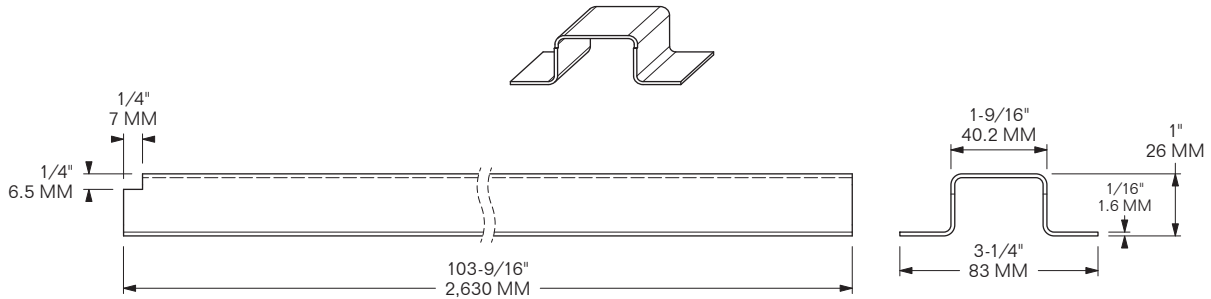

SUB FOR: MAERSK 7162459 **FITS:** MCIQ REEFER **LENGTH:** 103-9/16" / 2,630 MM
MATERIAL: CORTEN STEEL **FINISH:** PRIMER **WEIGHT:** 9.17 LBS / 4.16 Kg

MODEL 1212-6440

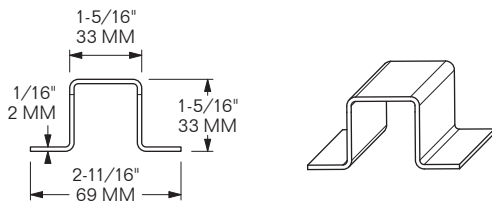

SUB FOR: MAERSK 7162456 **FITS:** MCIQ REEFER
LENGTH: 105-1/16" / 2,669 MM
MATERIAL: CORTEN STEEL **FINISH:** PRIMER
WEIGHT: 11.67 LBS / 5.3 Kg

MODEL 1212-7654

MODEL 1212-7655

for CIMC Reefer Containers

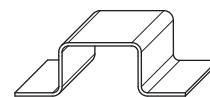
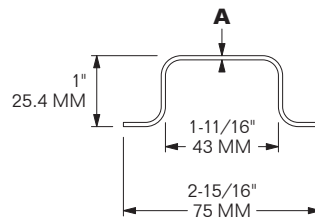

MODEL	A	LENGTH	MATERIAL	FINISH	WEIGHT	SUB FOR
1212-7654	1/16" / 1.6 MM	99-7/32" / 2,520 MM	CORTEN STEEL	WELDABLE PRIMER	7.2 LBS / 3.3 Kg	CIMC 07-003-1
1212-7655	1/32" / 0.8 MM	99-7/32" / 2,520 MM	MGSS	SELF-COLOR	3.5 LBS / 1.6 Kg	CIMC 07-003-2

MODEL 1212-2705

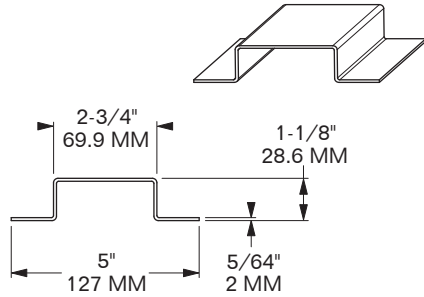

SUB FOR: MANAC 501-452, 501-480, HYUNDAI 10004293
LENGTH: 108" / 2,743 MM
MATERIAL: FAB. STEEL **FINISH:** ELECTRO-GALV.
WEIGHT: 15.5 LBS / 7 Kg

MODEL 1212-2711

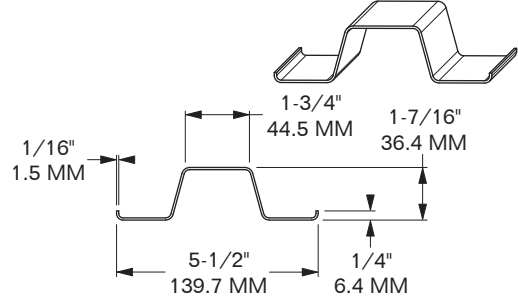

SUB FOR: STOUGHTON 03-06347-110-00
LENGTH: 110" / 2,794 MM
MATERIAL: FAB. STEEL **FINISH:** ELECTRO-GALV.
WEIGHT: 14.1 LBS / 6.4 Kg

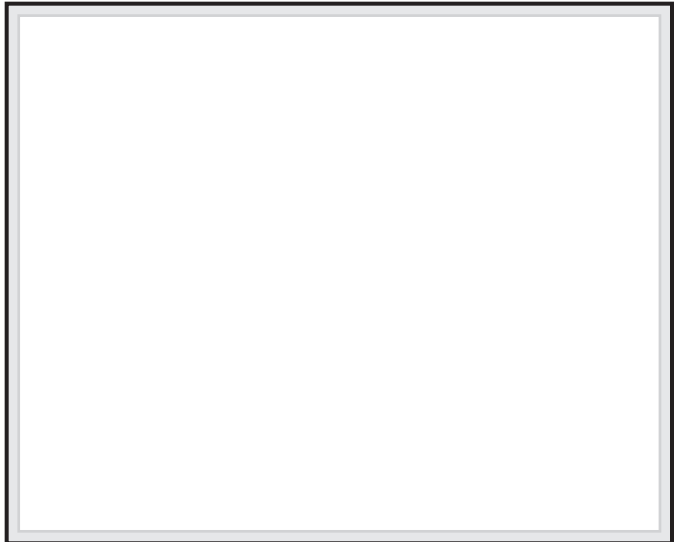
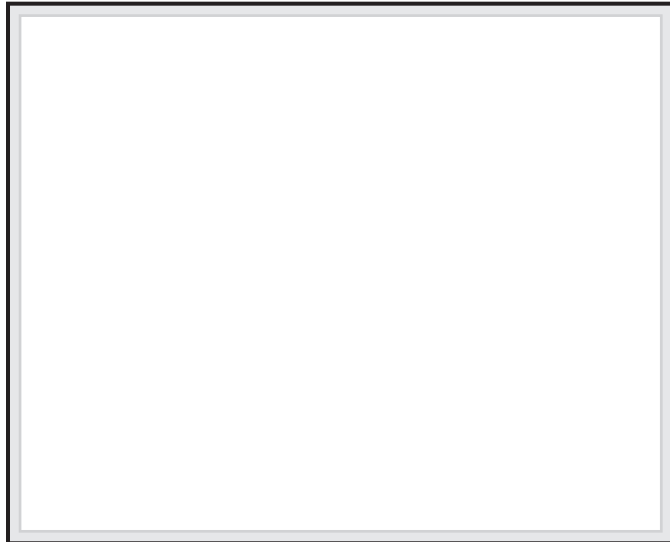
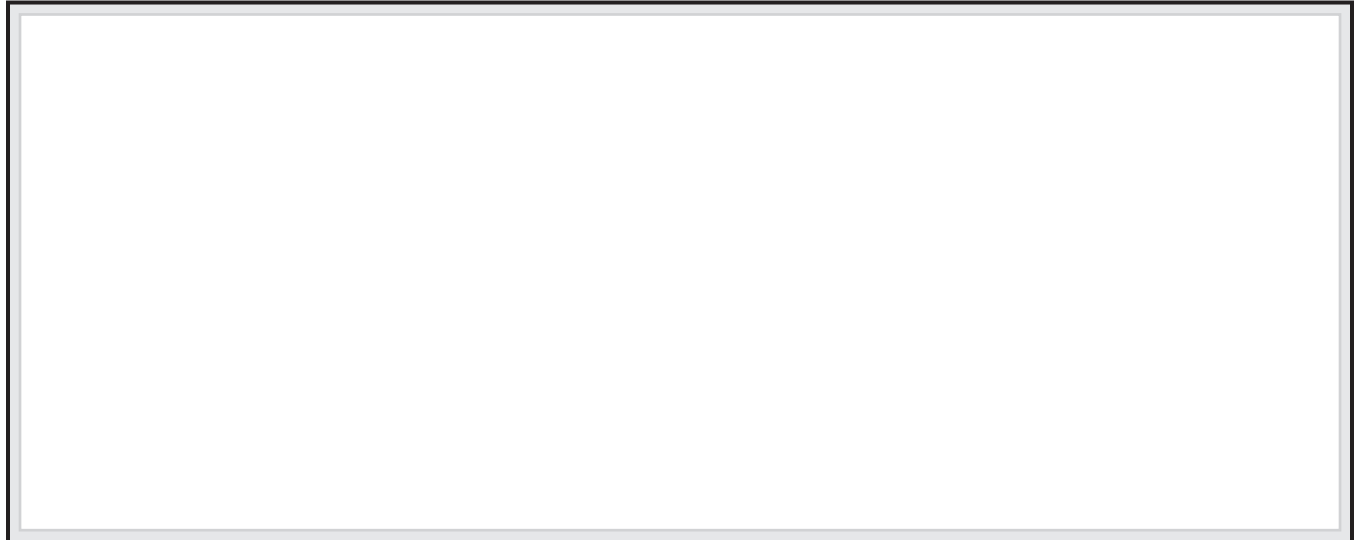

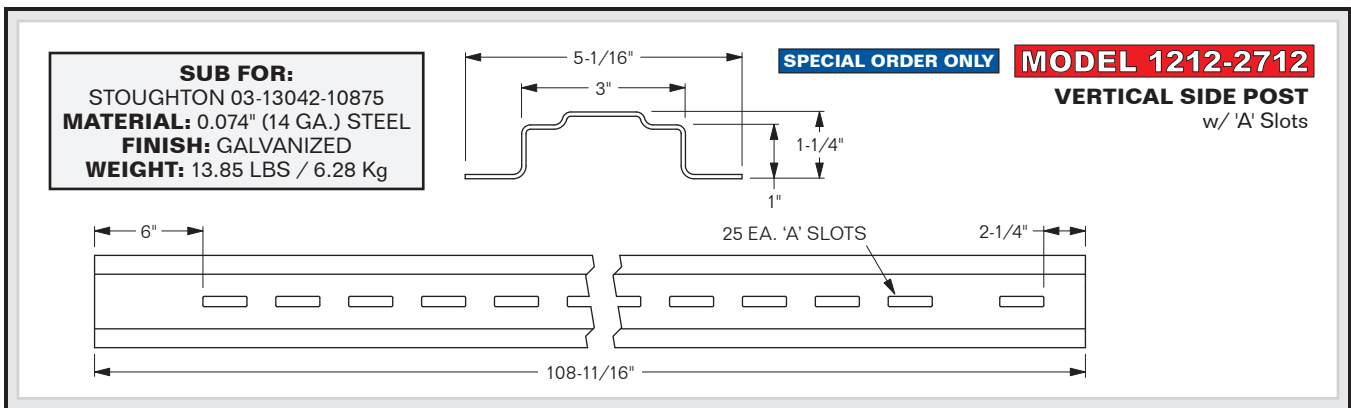
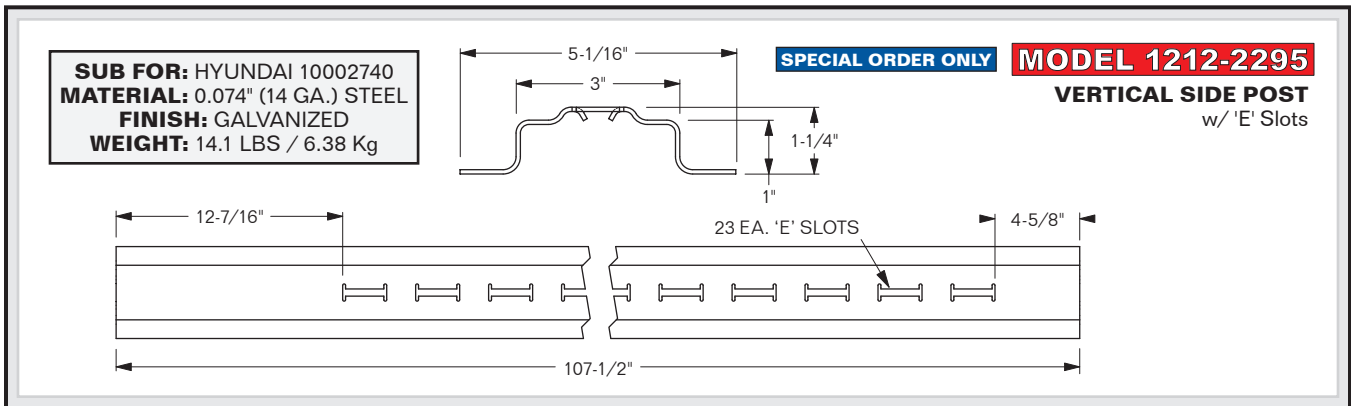



STAINLESS STEEL ROOF BOWS

REEFER CONTAINERS

SEE ALSO 1304-2 for ALUMINUM ROOF BOWS

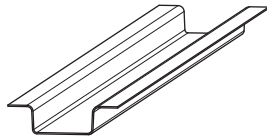

MODEL 1212-7021

ROOF BOW

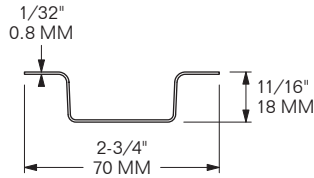

FITS: 40' REEFER CONTAINER
LENGTH: 92' / 2,337 MM
MATERIAL: FAB. STAINLESS STEEL
WEIGHT: 3.4 LBS / 1.54 Kg

SPECIAL ORDER ONLY

MODEL 1212-7565

ROOF BOW

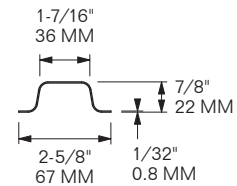
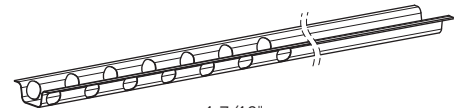
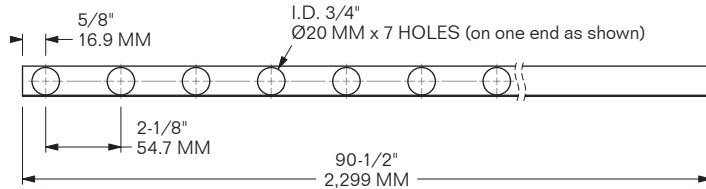
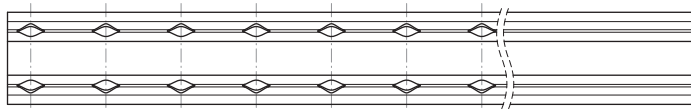

FITS: 40' REEFER CONTAINER **LENGTH:** 90-1/2" / 2,299 MM
MATERIAL: STAINLESS STEEL **FINISH:** SELF-COLOR **WEIGHT:** 2.93 LBS / 1.33 Kg

BUFFERS USA INC

"The Intermodal Hardware Specialists"

1212-4



904-696-0010

E-mail: sales@buffersusa.com

SPECIAL ORDER ONLY **MODEL 1212-2309**
ROOF BOW ASSEMBLY

3-11/16" / 93.8 MM
 2-7/8" / 73.2 MM
 4" / 101.8 MM

SUB FOR: STOUGHTON 23-06636-00000
LENGTH: 98-3/4" / 2,508 MM
MATERIAL: FAB. STEEL **FINISH:** GALVANIZED
WEIGHT: 9.9 LBS / 4.5 Kg

MODEL 1212-2716
ROOF BOW

1/16" / 1.5 MM
 3-7/16" / 87.3 MM
 1" / 25.4 MM

SUB FOR: HYUNDAI 10002725
LENGTH: 99-1/4" / 2,521 MM
MATERIAL: FAB. STEEL **FINISH:** GALVANIZED
WEIGHT: 9.3 LBS / 4.2 Kg

MODEL 1212-7021
ROOF BOW

1/16" / 0.8 MM
 2-3/4" / 70 MM
 11/16" / 18 MM

FITS: 40' REEFER CONTAINER
LENGTH: 92" / 2,337 MM
MATERIAL: FAB. STAINLESS STEEL
WEIGHT: 3.26 LBS / 1.58 Kg

MODEL 1212-8759
ROOF BOW

1" / 25.5 MM
 2-3/4" / 70 MM
 1-19/32" / 40.3 MM
 1" / 25.5 MM
 1/16" / 1.5 MM

SUB FOR: TRAILMOBILE 9514-3-78B
LENGTH: 99" / 2,515 MM
MATERIAL: FAB. STEEL **FINISH:** GALVANIZED
WEIGHT: 7.1 LBS / 3.2 Kg

MODEL 1212-8760
ROOF BOW

2-5/8" / 66 MM
 1-9/16" / 40.3 MM
 1" / 25.5 MM
 1-1/4" / 32.5 MM

SUB FOR: WABASH 07200028
LENGTH: 99" / 2,515 MM
MATERIAL: FAB. STEEL **FINISH:** GALVANIZED
WEIGHT: 7.30 LBS / 3.31 Kg