

Main **MODEL 1208-6271**  
 End **MODEL 1208-6271-6**  
**TOP SIDE RAIL**  
 Rectangular Tubing

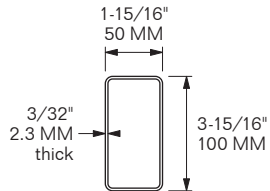

**6271 SUB FOR:** JINDO AH0301-0761,  
 J.B. HUNT 31920 **FITS:** JINDO 53' x 102"  
**MATERIAL:** CORTEN STEEL **FINISH:** PRIMER  
**6271 LENGTH:** 228" (19') / 5,791 MM  
**6271 WEIGHT:** 62 LBS / 28.12 Kg  
**6271-6 LENGTH:** 72" (6') / 1,829 MM  
**6271-6 WEIGHT:** 20.3 LBS / 9.21 Kg

**MODEL 1208-8977**  
**TOP SIDE RAIL**  
 Front Section (L/R)  
 Square Tubing

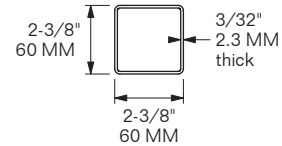

**SUB FOR:** SINGAMAS 53-305001  
**FITS:** SINGAMAS 53' / HUB  
**LENGTH:** 71" (5' 11") / 1,803 MM  
**MATERIAL:** CORTEN STEEL  
**FINISH:** WELDABLE PRIMER  
**WEIGHT:** 16.1 LBS / 7.3 Kg

**MODEL 1208-9000**

**TOP SIDE RAIL**  
 for Singamas 53'  
 Main, 18' 8" long

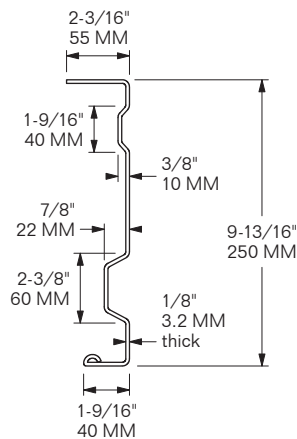

**SUB FOR:** SINGAMAS NS53-500001  
**FITS:** SINGAMAS 53'  
**LENGTH:** 224-7/16" (18' 8-7/16") / 5,700 MM  
**MATERIAL:** CORTEN STEEL **FINISH:** PRIMER  
**WEIGHT:** 118.6 LBS / 53.8 Kg

**MODEL 1208-6160**  
**MODEL 1208-6162**

**TOP RAIL, Flat Bar**

**FITS:** 96" ISO  
**LENGTH:** 20' / 6,096 MM  
**MATERIAL:** FAB. STEEL  
**FINISH:** SELF-COLOR

**1208-6160**  
**WEIGHT:** 67 LBS / 30.4 Kg

**1208-6162**  
**WEIGHT:** 83 LBS / 37.7 Kg

**MODEL 1208-2134**

**TOP RAIL**  
Square Tubing

**FITS:** 96" ISO  
**MATERIAL:** CORTEN STEEL  
**FINISH:** PRIMER  
**LENGTH:** 18' 8" / 5,700 MM  
**WEIGHT:** 65.1 LBS / 29.52 Kg

**MODEL 1208-2191**

**TOP RAIL**  
Inner, U-shape

**SUB FOR:** CIMC D09-03  
**FITS:** MAERSK DRY ISO  
**LENGTH:** 94-1/2" / 2,400 MM  
**MATERIAL:** CORTEN STEEL  
**FINISH:** PRIMER  
**WEIGHT:** 22.84 LBS / 10.6 Kg

**MODEL 1208-2192**

**TOP RAIL**  
Outer, W-shape

**SUB FOR:** CIMC D09-04  
**FITS:** MAERSK DRY ISO  
**LENGTH:** 94-1/2" / 2,400 MM  
**MATERIAL:** CORTEN STEEL  
**FINISH:** PRIMER  
**WEIGHT:** 26.8 LBS / 12.16 Kg

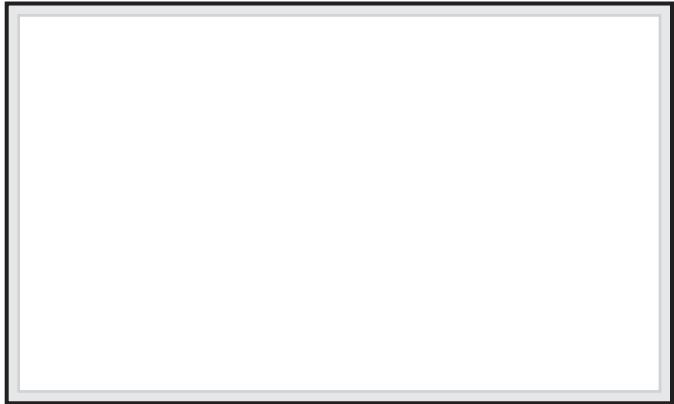
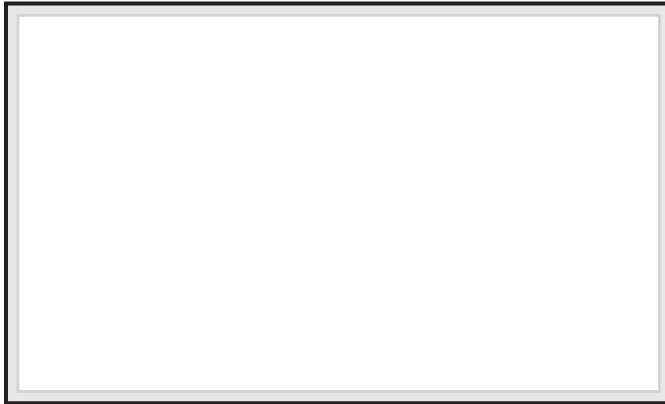
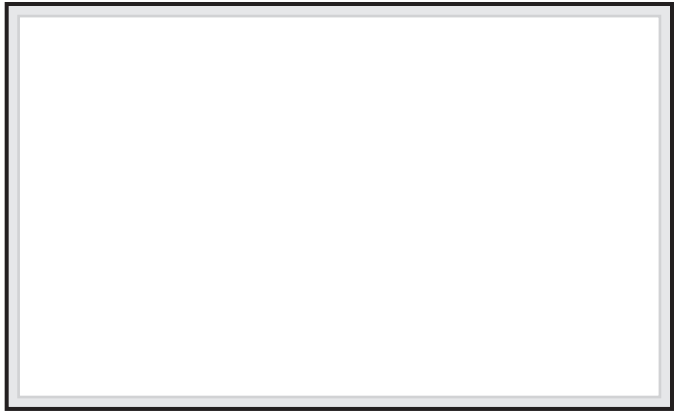
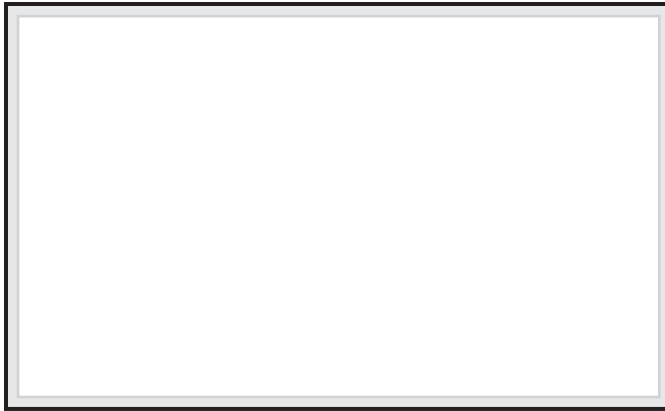

**MODEL 1208-6220-19**  
**TOP RAIL**

**SUB FOR:** MAERSK 7460029, CIMC 11-002 & SA01-C204-C0  
**FITS:** 40' HC REEFER  
**LENGTH:** 8' 8-1/2" / 5,702 MM  
**MATERIAL:** CORTEN STEEL  
**FINISH:** PRIMER  
**WEIGHT:** 73 LBS / 33.1 Kg

**MODEL 1208-6441-20**  
**TOP RAIL**

**SUB FOR:** MAERSK 7460006  
**FITS:** MCIQ 40' HC REEFER  
**LENGTH:** 19' 8-1/4" / 6,000 MM  
**MATERIAL:** CORTEN STEEL  
**FINISH:** PRIMER  
**WEIGHT:** 88.4 LBS / 40.1 Kg

**MODEL 1208-6442**  
**FRONT TOP RAIL**

**SUB FOR:** MAERSK 7132952  
**FITS:** MCIQ 40' REEFER  
**LENGTH:** 91-3/16" / 2,316 MM  
**MATERIAL:** CORTEN STEEL  
**FINISH:** PRIMER  
**WEIGHT:** 78 LBS / 35.4 Kg

**MODEL 1208-7465**  
**TOP RAIL**

**FITS:** SINGAMAS 40' REEFER  
**LENGTH:** 18' 8-1/2" / 5,702 MM  
**MATERIAL:** CORTEN STEEL  
**FINISH:** PRIMER  
**WEIGHT:** 92.05 LBS / 41.75 Kg



1-13/16"  
46.5 MM

**SPECIAL ORDER ONLY** **MODEL 1208-7645**

**TOP RAIL**

1-3/16"  
30 MM

5-7/8"  
150 MM

5/32"  
4 MM

**SUB FOR:** CIMC 11-001  
**FITS:** CIMC 40' REEFER  
**LENGTH:** 19' 6" / 5,944 MM  
**MATERIAL:** CORTEN STEEL  
**FINISH:** PRIMER  
**WEIGHT:** 85.8 LBS / 38.9 Kg

2-7/16"  
62 MM

25/32"  
20 MM

**MODEL 1208-7691**

**TOP RAIL**

6-3/8"  
162 MM

5/32"  
4 MM

**FITS:** CIMC, SINGAMAS  
 40' HIGH CUBE REEFER  
**LENGTH:** 19' / 5,791 MM  
**MATERIAL:** CORTEN STEEL  
**FINISH:** PRIMER  
**WEIGHT:** 93.7 LBS / 42.5 Kg

3"  
76 MM

1-3/16"  
31 MM

**MODEL 1208-7974**

**TOP RAIL**

4-7/8"  
124 MM

5/32"  
4 MM

**SUB FOR:** MAERSK 285001  
**FITS:** MAERSK TINGLEV  
 40' HIGH CUBE REEFER  
**LENGTH:** 95-1/2" / 2,426 MM  
**MATERIAL:** CORTEN STEEL  
**FINISH:** PRIMER  
**WEIGHT:** 38.7 LBS / 17.6 Kg

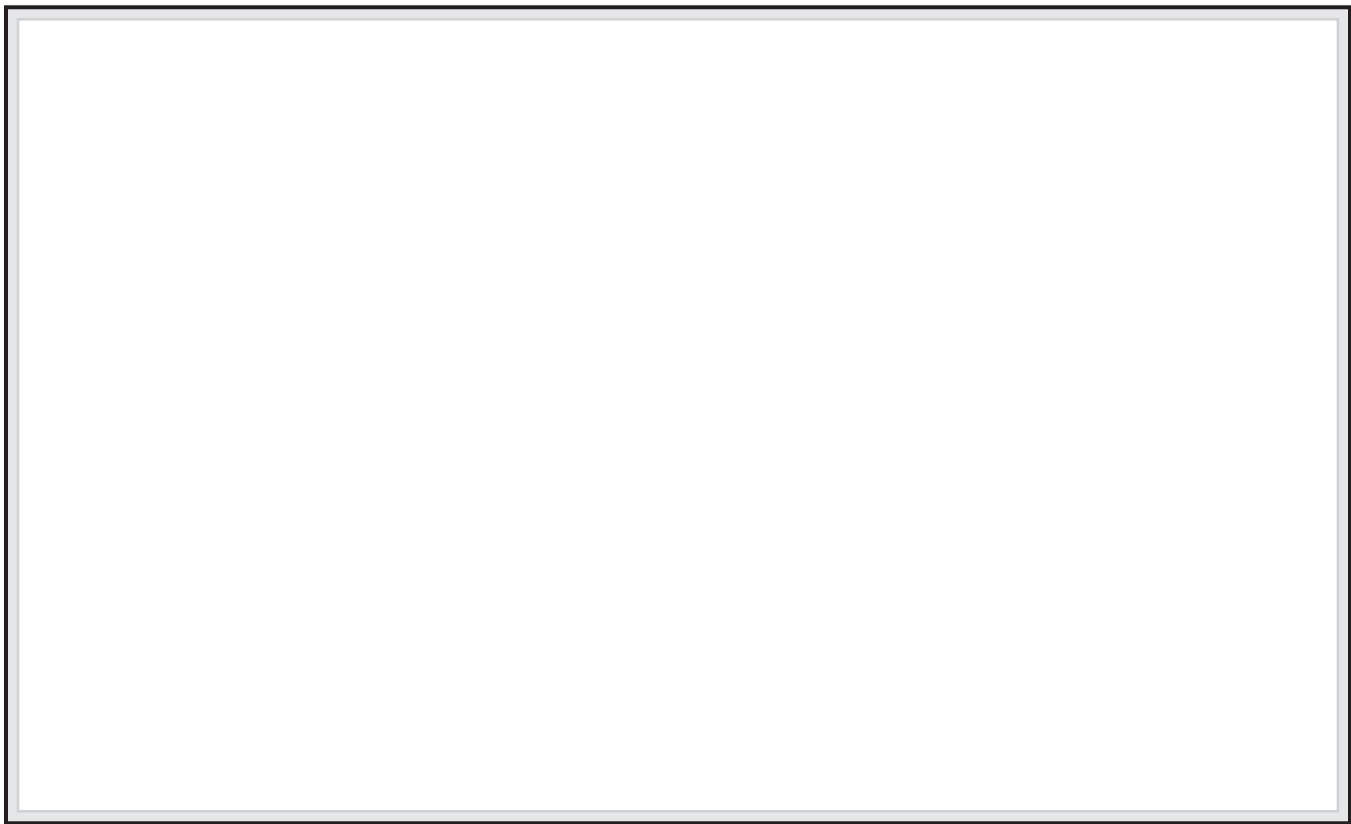



# STEEL SIDE RAILS BOTTOM DOMCON CONTAINERS

**MODEL 1208-6207**  
**BOTTOM SIDE RAIL**

**SUB FOR:** JINDO I02317-4015  
**FITS:** JINDO 48', 53' / CSX, HUB, PACER, SWIFT & CIMC HC53-04B-9 / CROWLEY  
**LENGTH:** 19' / 5,791 MM  
**MATERIAL:** CORTEN STEEL  
**FINISH:** PRIMER  
**WEIGHT:** 159.8 LBS / 72.5 Kg

**MODEL 1208-6213**  
**BOTTOM SIDE RAIL**

**SUB FOR:** JINDO I02317-4026  
**FITS:** JINDO 53' / PACER, CSX  
**LENGTH:** 19' / 5,791 MM  
**MATERIAL:** CORTEN STEEL  
**FINISH:** PRIMER  
**WEIGHT:** 146 LBS / 66.2 Kg

**MODEL 1208-6215**  
**BOTTOM SIDE RAIL**

**SUB FOR:** JINDO I02317-4019  
**FITS:** JINDO 53' / PACER, CSX  
**LENGTH:** 19' / 5,791 MM  
**MATERIAL:** CORTEN STEEL  
**FINISH:** PRIMER  
**WEIGHT:** 145 LBS / 65.77 Kg

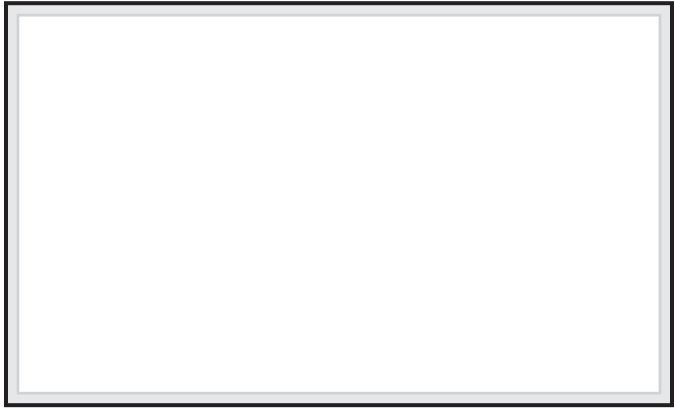
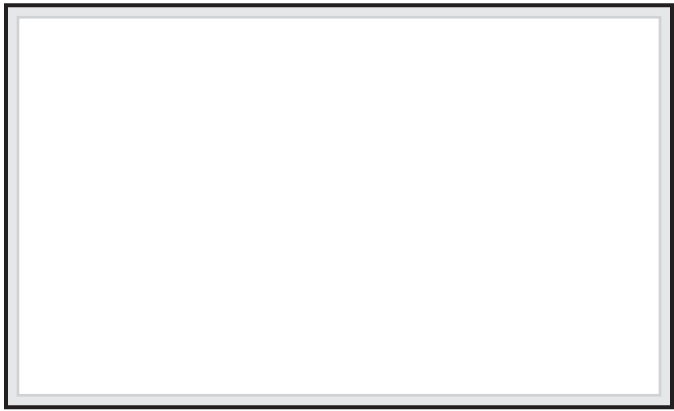
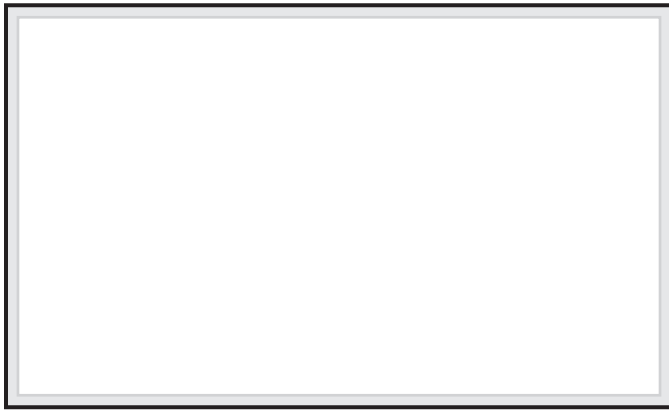

**ROADSIDE**

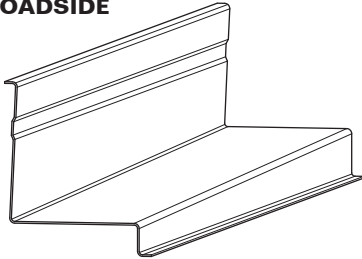

**CURBSIDE**

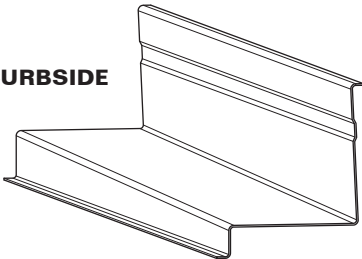

**SPECIAL ORDER ONLY** **MODEL 1208-7156-CS**

**SPECIAL ORDER ONLY** **MODEL 1208-7156-RS**

**BOTTOM SIDE RAIL**

Door End Sections,  
Sloping Floor

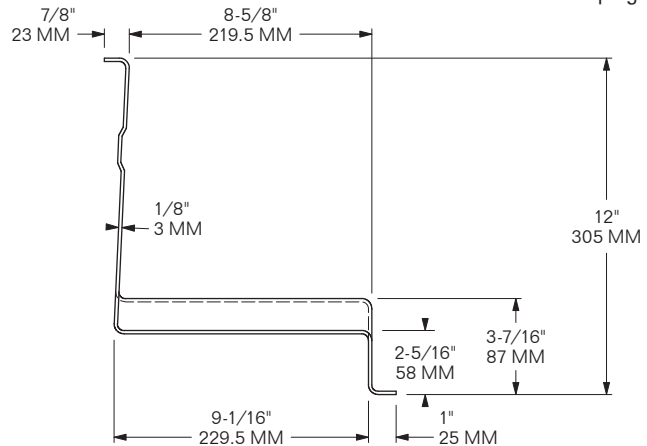

**FITS:** SINGAMAS 53' / FERROMEX, J.B. HUNT **LENGTH:** 71" / 1,803 MM  
**MATERIAL:** H.S. STEEL **FINISH:** PRIMER **WEIGHT:** 53.1 LBS / 24.09 Kg

**MODEL 1208-7139**

**BOTTOM SIDE RAIL**  
 Front & Rear End Sections

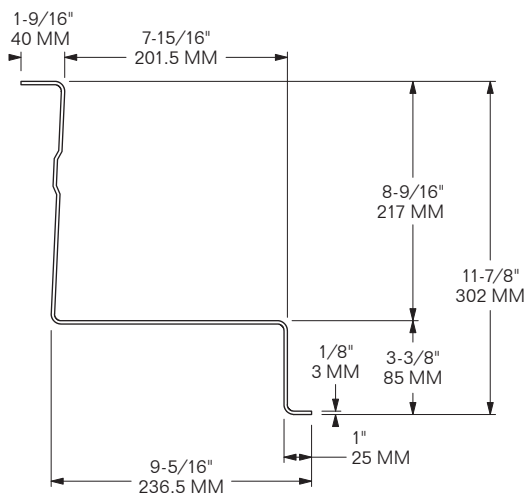

**FITS:** SINGAMAS 53' / FERROMEX, J.B. HUNT  
**LENGTH:** 71" / 1,803 MM **MATERIAL:** H.S. STEEL  
**FINISH:** PRIMER **WEIGHT:** 52.1 LBS / 23.63 Kg

**MODEL 1208-7929**

**BOTTOM SIDE RAIL, Z-type,**  
 Front & Rear End Sections

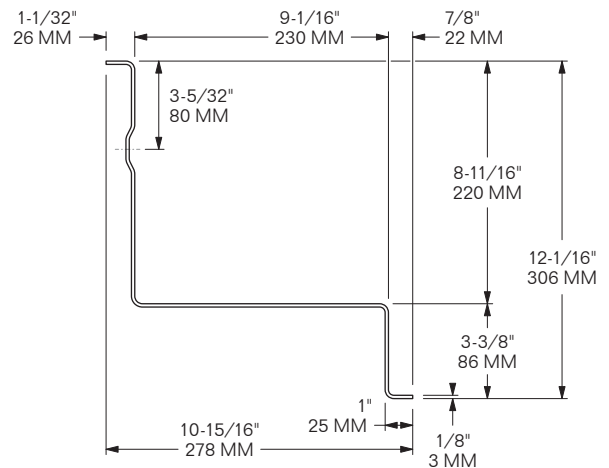

**FITS:** J.B. HUNT 31919, SINGAMAS QPJH-400280  
**FITS:** SINGAMAS 53' / J.B. HUNT  
**LENGTH:** 5' 11-1/16" / 1,805 MM  
**MATERIAL:** CORTEN STEEL **FINISH:** PRIMER  
**WEIGHT:** 51.4 LBS / 23.3 Kg

### MODEL 1208-7935

#### BOTTOM SIDE RAIL Main

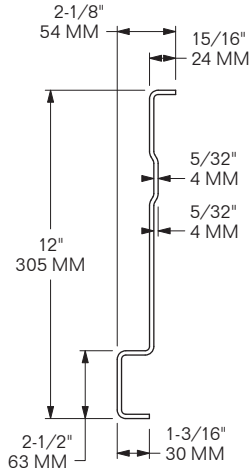

**SUB FOR:** CIMC AD53-0103B-8,  
J.B. HUNT 31921 & SINGAMAS QPH-200001  
**FITS:** CIMC, SINGAMAS 53' / J.B. HUNT  
**LENGTH:** 19' 5-1/16" / 5,920 MM  
**MATERIAL:** CORTEN STEEL **FINISH:** PRIMER  
**WEIGHT:** 148.2 LBS / 67.22 Kg

### MODEL 1208-8135

#### BOTTOM SIDE RAIL End Section

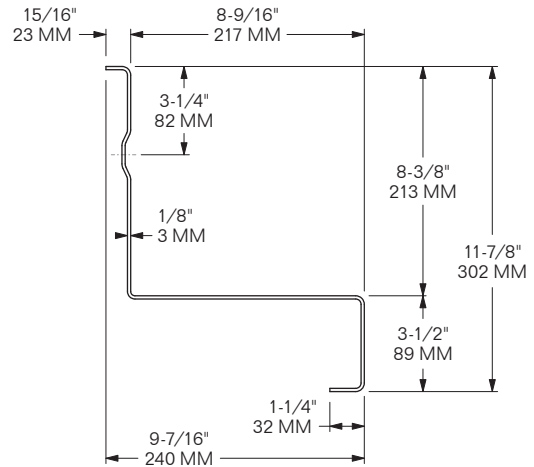

**SUB FOR:** CIMC AD53-0103F-14  
**FITS:** CIMC 53' / J.B. HUNT  
**LENGTH:** 5' 10-15/16" / 1,802 MM  
**MATERIAL:** CORTEN STEEL **FINISH:** PRIMER  
**WEIGHT:** 52 LBS / 23.6 Kg

### MODEL 1208-8976

#### BOTTOM RAIL, Front Rectangular Tubing

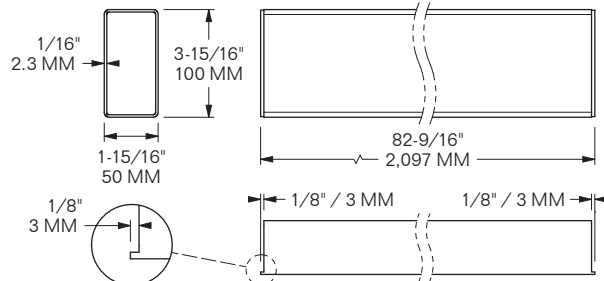
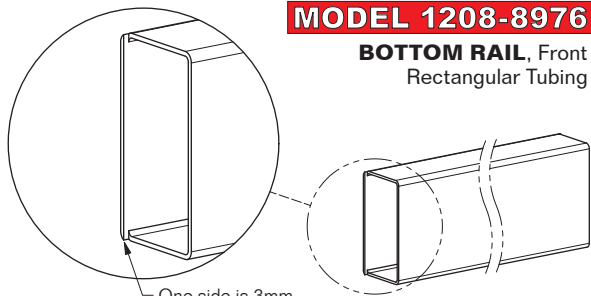

**SUB FOR:** SINGAMAS 53-302001  
**FITS:** SINGAMAS 53' / HUB  
**MATERIAL:** CORTEN STEEL **FINISH:** WELDABLE PRIMER  
**WEIGHT:** 23.9 LBS / 10.84 Kg

### MODEL 1208-6191

#### BOTTOM RAIL

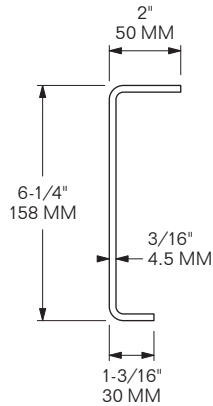

**SUB FOR:** CIMC D08-01C **FITS:** 20' & 40' x 96" ISO  
**LENGTH:** 18' 8" / 5,690 MM  
**MATERIAL:** CORTEN STEEL  
**FINISH:** WELDABLE PRIMER  
**WEIGHT:** 97.5 LBS / 44.2 Kg

### MODEL 1208-7059

#### BOTTOM RAIL

Z-type

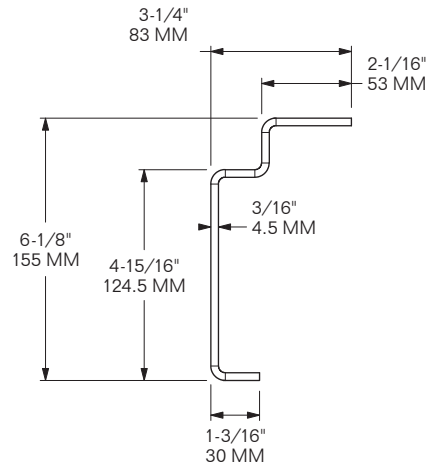

**SUB FOR:** CIMC D08-02 **FITS:** 40' ISO  
**LENGTH:** 18' 8-1/2" / 5,702 MM  
**MATERIAL:** CORTEN STEEL  
**FINISH:** WELDABLE PRIMER  
**WEIGHT:** 99 LBS / 44.9 Kg



**MODEL 1208-6217**  
**MODEL 1208-6217-19**

**BOTTOM RAIL, Lower**

**FITS:** MCIQ/TRITON 40' HC  
**MATERIAL:** CORTEN STEEL  
**FINISH:** PRIMER

**1208-6217**  
**SUB FOR:** MAERSK 7420014 & 7460817  
**LENGTH:** 38' 10" / 11,838 MM  
**WEIGHT:** 134.7 LBS / 61.1 Kg

**1208-6217-19**  
**LENGTH:** 19' / 5,791 MM  
**WEIGHT:** 67 LBS / 30.4 Kg

**MODEL 1208-6218**  
**MODEL 1208-6218-19**

**BOTTOM RAIL, Upper**

**FITS:** MCIQ/TRITON 40' HC  
**MATERIAL:** CORTEN STEEL  
**FINISH:** PRIMER

**1208-6218**  
**SUB FOR:** MAERSK 7460716  
**LENGTH:** 38' 10" / 11,838 MM  
**WEIGHT:** 128.6 LBS / 58.3 Kg

**1208-6218-19**  
**LENGTH:** 19' 5" / 5,918 MM  
**WEIGHT:** 64.3 LBS / 29.1 Kg

MODEL #	A	B	C	WEIGHT	SUB FOR
<b>1208-7647</b>	1" / 25 MM	4-1/8" / 105 MM	1" / 25 MM	35 LBS / 15.9 Kg	CIMC 02-013
<b>1208-7648</b>	1" / 25 MM	5-1/16" / 128 MM	1" / 25 MM	37 LBS / 16.8 Kg	CIMC 02-007, 02-011
<b>1208-7649</b>	1" / 25 MM	5-7/8" / 150 MM	1" / 25 MM	41 LBS / 18.6 Kg	CIMC 02-012
<b>1208-7650</b>	1-9/16" / 40 MM	5-7/8" / 150 MM	1" / 25 MM	45 LBS / 20.4 Kg	CIMC 02-014

**BOTTOM RAILS**

**FITS:** CIMC 40' REEFER **LENGTH:** 9' 10-1/8" / 3,000 MM  
**MATERIAL:** CORTEN STEEL **FINISH:** WELDABLE PRIMER

**MODEL 1208-7651**

**BOTTOM RAIL**

**SUB FOR:** CIMC 07-012  
**FITS:** CIMC 40' REEFER  
**LENGTH:** 9' 10-1/8" / 3,000 MM  
**MATERIAL:** CORTEN STEEL  
**FINISH:** WELDABLE PRIMER  
**WEIGHT:** 30.1 LBS / 13.7 Kg

**MODEL 1208-7652**

**BOTTOM RAIL**

**SUB FOR:** CIMC 07-013  
**FITS:** CIMC 40' REEFER  
**LENGTH:** 9' 10-1/8" / 3,000 MM  
**MATERIAL:** CORTEN STEEL  
**FINISH:** WELDABLE PRIMER  
**WEIGHT:** 32.1 LBS / 14.6 Kg

**MODEL 1208-7705-18.7**

**BOTTOM RAIL**  
Upper

**FITS:** CIMC 40' REEFER  
**LENGTH:** 18' 8" / 5,690 MM  
**MATERIAL:** CORTEN STEEL  
**FINISH:** WELDABLE PRIMER  
**WEIGHT:** 62.16 LBS / 28.2 Kg

**MODEL 1208-7706**

**BOTTOM RAIL**  
Reinforcement L-plate

**SUB FOR:** CIMC SA04-A202-C0  
**FITS:** CIMC 40' REEFER  
**MATERIAL:** CORTEN STEEL  
**FINISH:** WELDABLE PRIMER  
**WEIGHT:** 8.3 LBS / 3.77 Kg

**SPECIAL ORDER ONLY** **MODEL 1208-8519**

**BOTTOM RAIL**  
Upper, Outer

**FITS:** MAERSK MCIQ 40' HC REEFER  
**WORKS WITH:** 1208-8522 LOWER-INNER RAIL  
**LENGTH:** 223-1/4" or 18' 7-1/4" / 5,671 MM  
**MATERIAL:** CORTEN STEEL **FINISH:** PRIMER  
**WEIGHT:** 76 LBS / 34.47 Kg

**SPECIAL ORDER ONLY** **MODEL 1208-8522**

**BOTTOM RAIL**  
Lower, Inner

**FITS:** MAERSK MCIQ 40' HC REEFER  
**WORKS WITH:** 1208-8519 UPPER-OUTER RAIL  
**LENGTH:** 224-5/8" OR 18' 8-5/8" / 5,706 MM  
**MATERIAL:** CORTEN STEEL **FINISH:** PRIMER  
**WEIGHT:** 50 LBS / 22.68 Kg



**SPECIAL ORDER ONLY**

**MODEL 1208-7142-L**

**SPECIAL ORDER ONLY**

**MODEL 1208-7142-R**

**REINFORCEMENT PLATES**

Corner Post to Bottom Side Rail,  
Type B

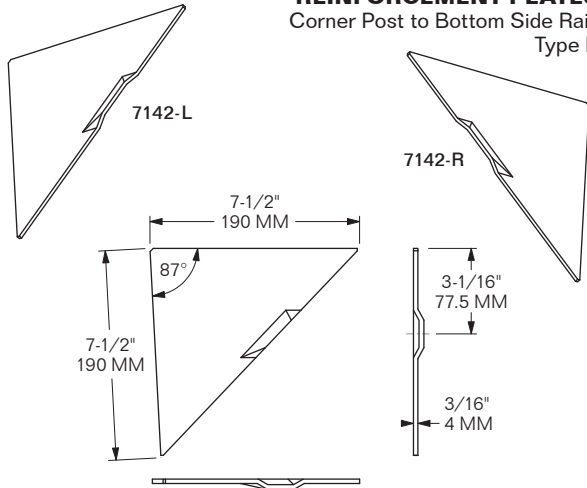

1208-7142-R is shown dimensioned.  
1208-7142-L is the mirror opposite.

**FITS:** 53' FERROMEX, SINGAMAS  
**THICKNESS:** 8 GA. / 4 MM **MATERIAL:** CORTEN STEEL  
**FINISH:** PRIMER **WEIGHT:** 1.17 LBS / 0.53 Kg

**SPECIAL ORDER ONLY**

**MODEL 1208-7143**

**REINFORCEMENT ANGLE**  
Type C

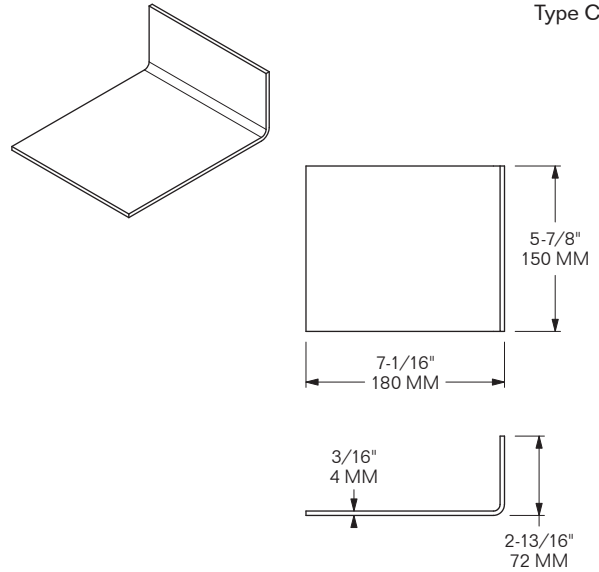

**FITS:** 53' FERROMEX, SINGAMAS  
**THICKNESS:** 8 GA. / 4 MM **MATERIAL:** CORTEN STEEL  
**FINISH:** PRIMER **WEIGHT:** 2.52 LBS / 1.14 Kg

**SPECIAL ORDER ONLY**

**MODEL 1208-7144-BL**

**SPECIAL ORDER ONLY**

**MODEL 1208-7144-BR**

**REINFORCEMENT PLATES**

Bottom Corner Casting to Bottom Side Rail,  
Type D

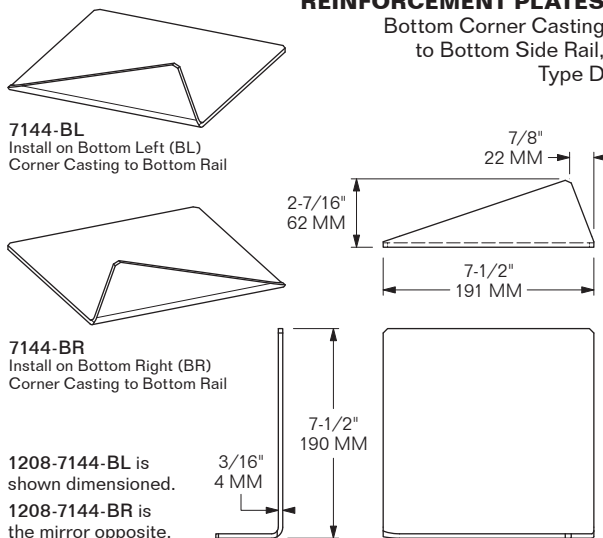

7144-BL  
Install on Bottom Left (BL)  
Corner Casting to Bottom Rail

7144-BR  
Install on Bottom Right (BR)  
Corner Casting to Bottom Rail

1208-7144-BL is shown dimensioned.  
1208-7144-BR is the mirror opposite.

**FITS:** 53' FERROMEX, SINGAMAS  
**THICKNESS:** 8 GA. / 4 MM **MATERIAL:** CORTEN STEEL  
**FINISH:** PRIMER **WEIGHT:** 2.68 LBS / 1.22 Kg

**SPECIAL ORDER ONLY**

**REINFORCEMENT ANGLES**  
Bottom Side Rail

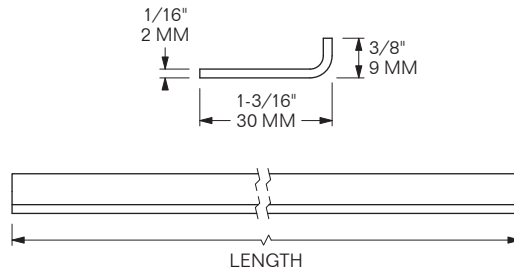

MODEL	LENGTH	WEIGHT
<b>1208-7145-1100</b>	43-5/16" 1,100 MM	1.3 LBS 0.59 Kg
<b>1208-7145-1780</b>	70-1/16" 1,780 MM	2 LBS 0.91 Kg
<b>1208-7145-1940</b>	76-3/8" 1,940 MM	2.15 LBS 0.96 Kg

**FITS:** 53' FERROMEX, SINGAMAS  
**THICKNESS:** 14 GA. / 2 MM **MATERIAL:** CORTEN STEEL  
**FINISH:** PRIMER **WEIGHTS:** PER ABOVE TABLE