

MODEL 1202-2138

for Jindo & 102" DomCon (1.6 MM thick)

MODEL 1202-6887

for CSX, J.B. Hunt & Jindo 53' (1.1 MM thick)

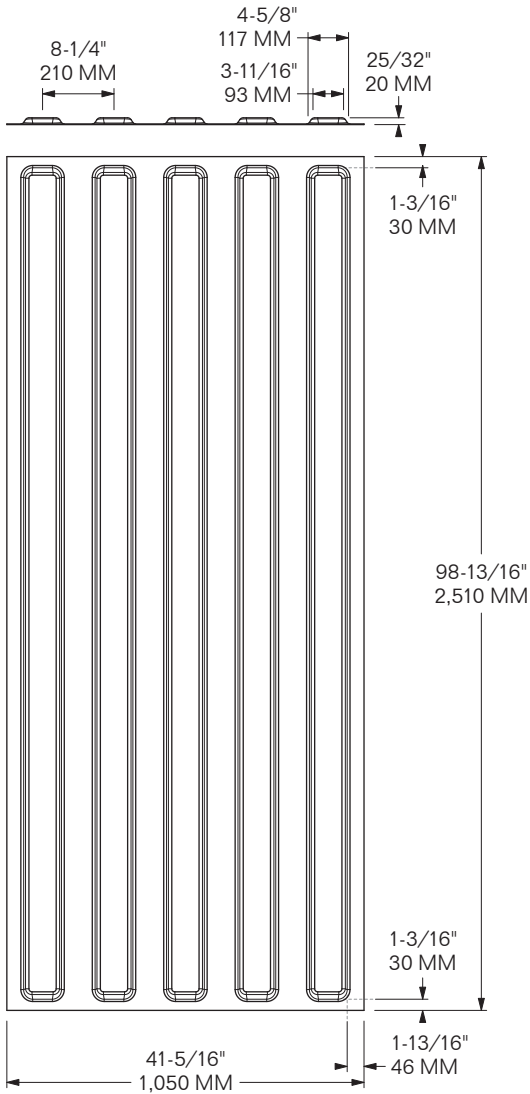

1202-2138 SUB FOR: JINDO AK0101-0790
FITS: 102" DOMCON **THICKNESS:** 1/16" / 1.6 MM
MATERIAL: CORTEN STEEL **FINISH:** PRIMER
WEIGHT: 76 LBS / 34.47 Kg

1202-6887 SUB FOR: BUI 1202-8162, HUB 53-405001, JBH 31832 & QPJH53-600001 & JINDO AK0101-0811
FITS: CSX, J.B. HUNT & JINDO 53'
THICKNESS: 3/64" / 1.1 MM
MATERIAL: DOCOL (H.S. STEEL) **FINISH:** PRIMER
WEIGHT: 53.4 LBS / 24.12 Kg

MODEL 1202-7908

for CIMC & J.B. Hunt 53'

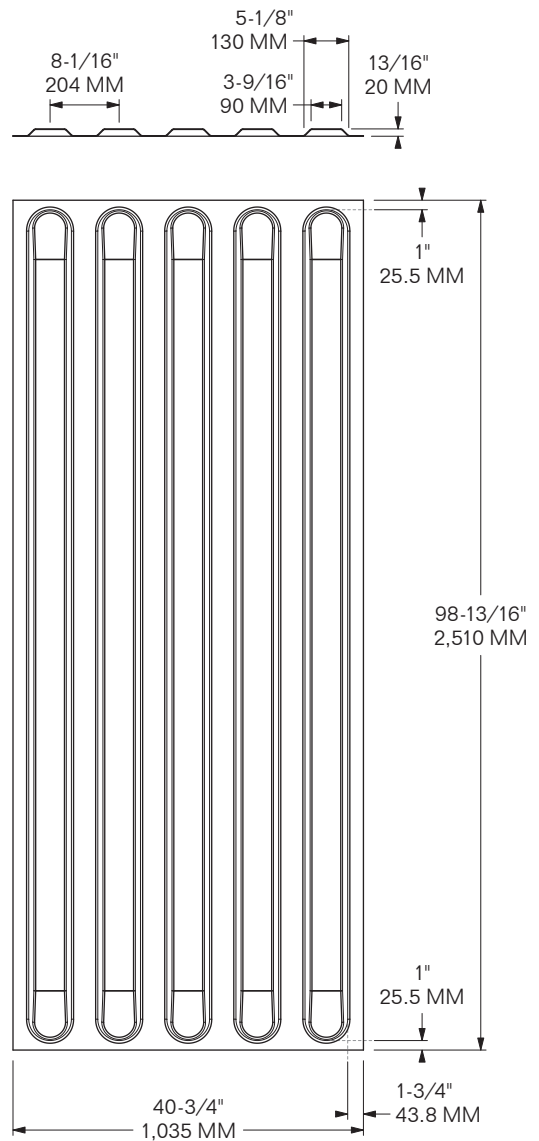

SUB FOR: CIMC AD53-0301R-1, JBH 31701
FITS: CIMC, J.B. HUNT 53'
THICKNESS: 1/16" / 1.6 MM
MATERIAL: DOCOL STEEL **FINISH:** PRIMER
WEIGHT: 75.2 LBS / 34.11 Kg

MODEL 1202-8162

for Ferromex, Hub, J.B. Hunt,
Singamas & Swift 53' x 102"

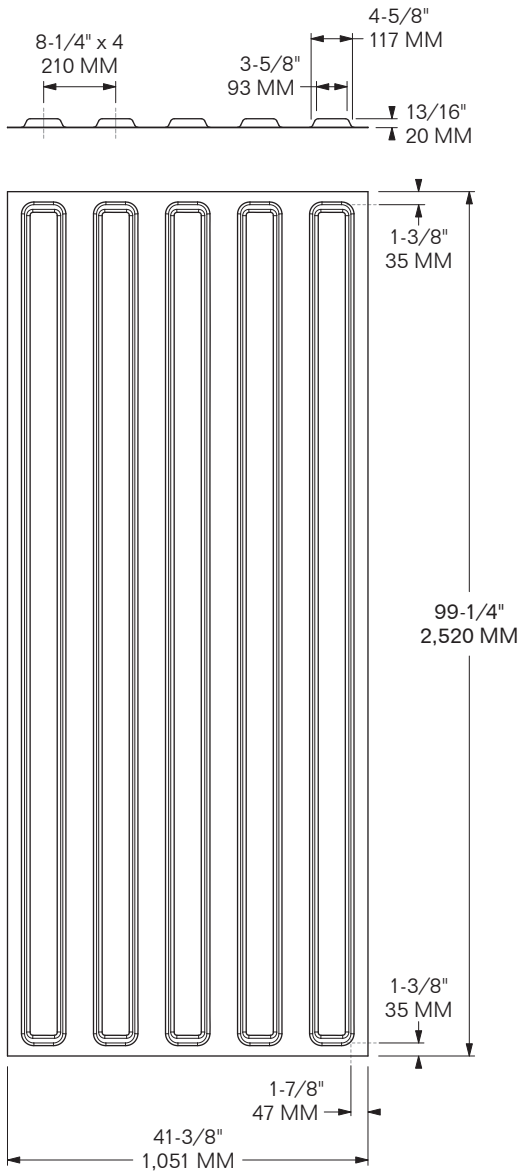

SUB FOR: SINGAMAS 53-600001, 53-600003, 53-600004
FITS: SINGAMAS 53' x 102" / FERROMEX, HUB,
 J.B. HUNT, SWIFT **THICKNESS:** 3/64" / 1.2 MM
MATERIAL: DOCOL STEEL **FINISH:** PRIMER
WEIGHT: 59.5 LBS / 27 Kg

MODEL 1202-8515

for CIMC, CSX & Singamas 53'

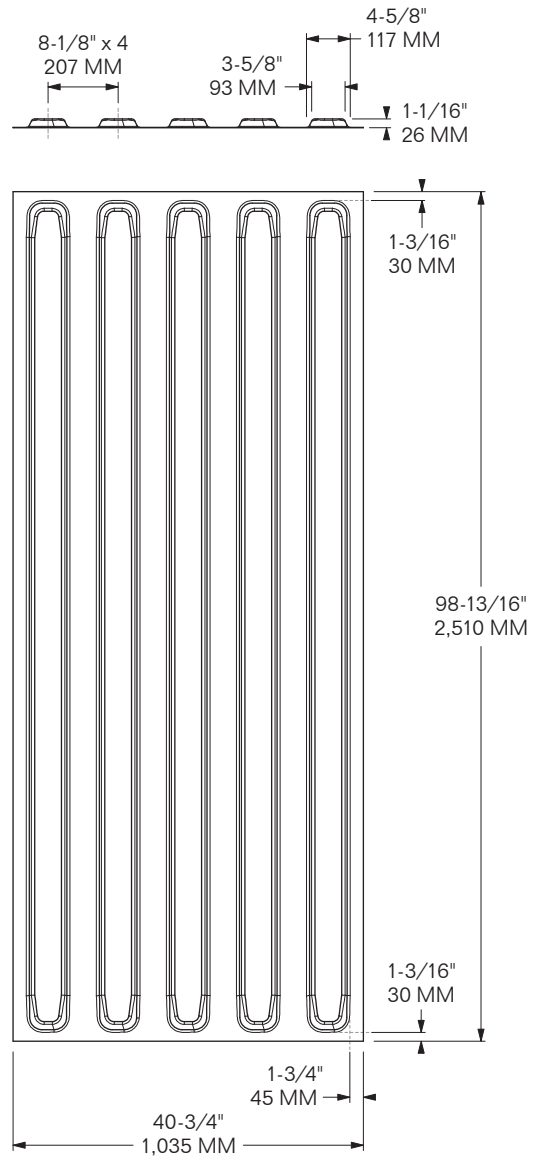

SUB FOR: CIMC AD53-0101R-5
FITS: CIMC, SINGAMAS 53' / CSX
THICKNESS: 3/64" / 1.2 MM
MATERIAL: DOCOL STEEL **FINISH:** PRIMER
WEIGHT: 60.4 LBS / 27.4 Kg

MODEL 1202-8163

for Ferromex, Hub, J.B. Hunt,
Singamas, Swift 53' x 102"

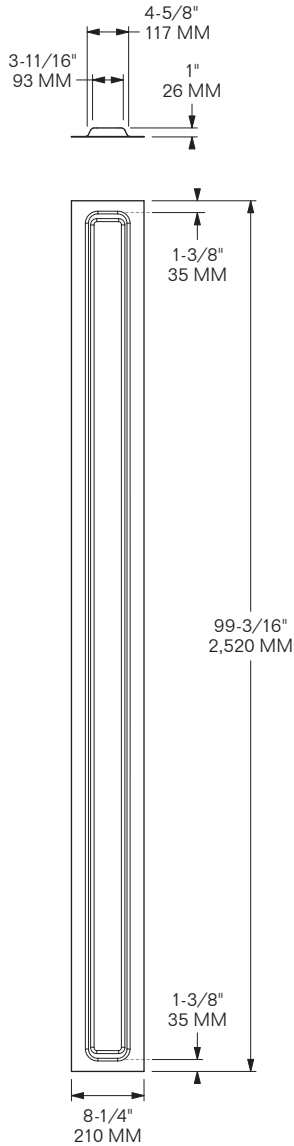

SUB FOR: SINGAMAS 53-600005
FITS: FERROMEX, HUB, J.B. HUNT,
 SINGAMAS, SWIFT 53' x 102"
WORKS WITH: BUFFERS 1202-8162
THICKNESS: 3/64" / 1.2 MM
MATERIAL: DOCOL STEEL **FINISH:** PRIMER
WEIGHT: 12 LBS / 5.44 Kg

MODEL 1202-8985

Front & Rear for Hub, Singamas 53'

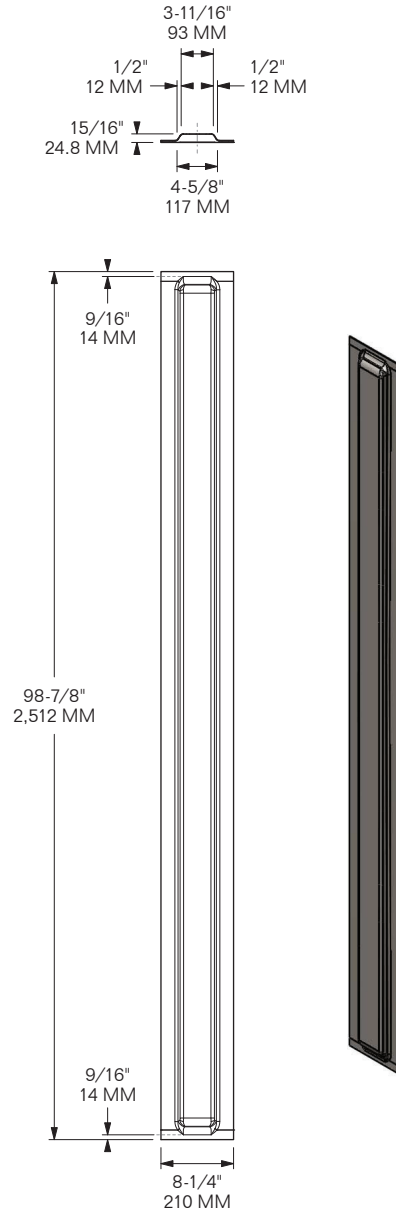

SUB FOR: SINGAMAS 53-600005
FITS: HUB, SINGAMAS 53'
THICKNESS: 3/64" / 1.2 MM
MATERIAL: DOCOL STEEL **FINISH:** PRIMER
WEIGHT: 11.91 LBS / 5.4 Kg

MODEL 1202-2118

3-Rib, Square Ends for 96" ISO

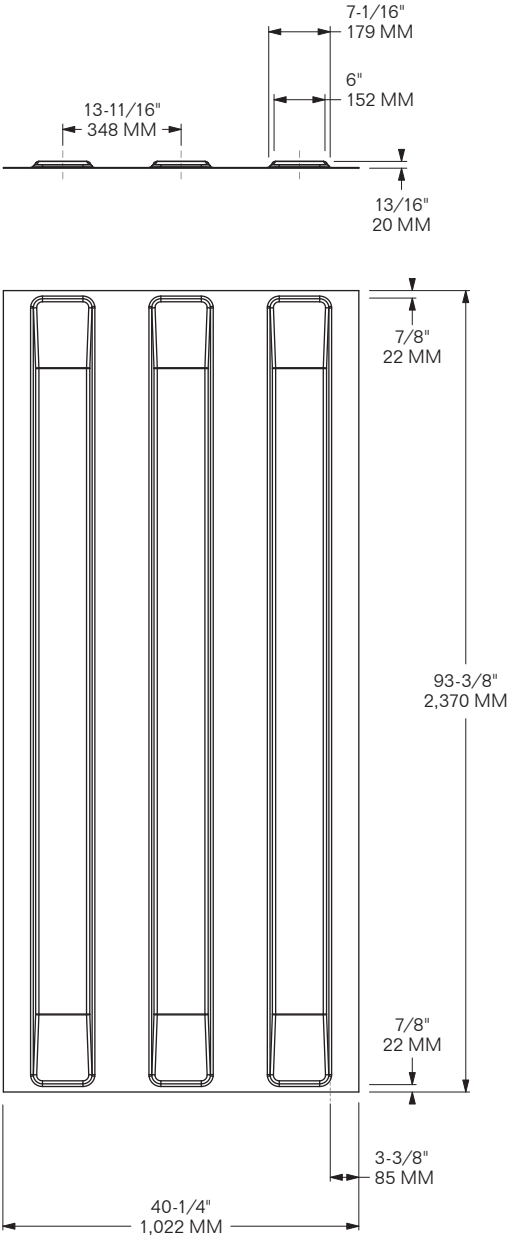

SUB FOR: CIMC D01-03
FITS: 96" ISO **THICKNESS:** 5/64" / 2 MM
MATERIAL: CORTEN STEEL **FINISH:** PRIMER
WEIGHT: 76 LBS / 34.47 Kg

MODEL 1202-2232

4-Rib, V-Ends for 96" ISO

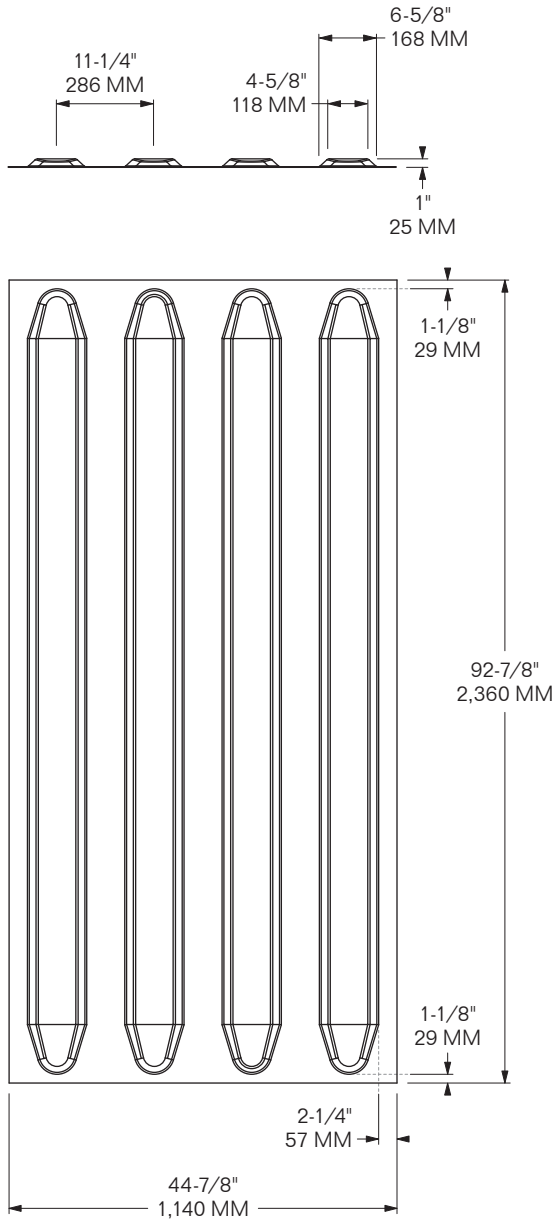

SUB FOR: BUI CRP-4V, CIMC D01-04
FITS: 96" ISO **THICKNESS:** 5/64" / 2 MM
MATERIAL: CORTEN STEEL **FINISH:** PRIMER
WEIGHT: 92 LBS / 41.73 Kg

MODEL 1202-2117

for Standard 96" ISO (2 MM thick)

MODEL 1202-2463

for Standard 96" ISO (1.6 MM thick)

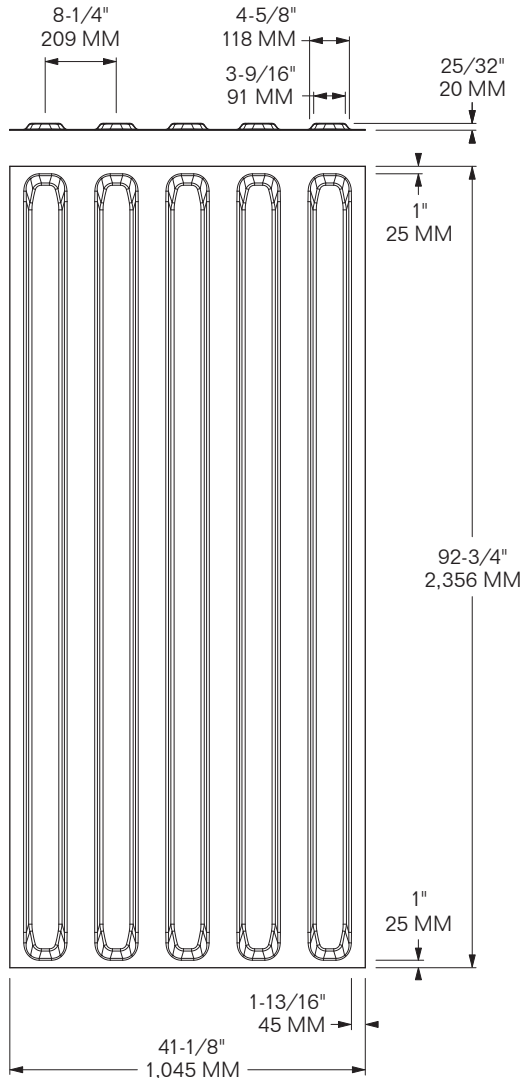

1202-2117 SUB FOR: CIMC D01-01
FITS: STANDARD 96" ISO **THICKNESS:** 5/64" / 2 MM
MATERIAL: CORTEN STEEL **FINISH:** PRIMER
WEIGHT: 91 LBS / 41.28 Kg

1202-2463 SUB FOR: CIMC D01-01-2
FITS: STANDARD 96" ISO **THICKNESS:** 1/16" / 1.6 MM
MATERIAL: CORTEN STEEL **FINISH:** PRIMER
WEIGHT: 75 LBS / 34.02 Kg

MODEL 1202-2149

for Standard 96" ISO, Square Ends

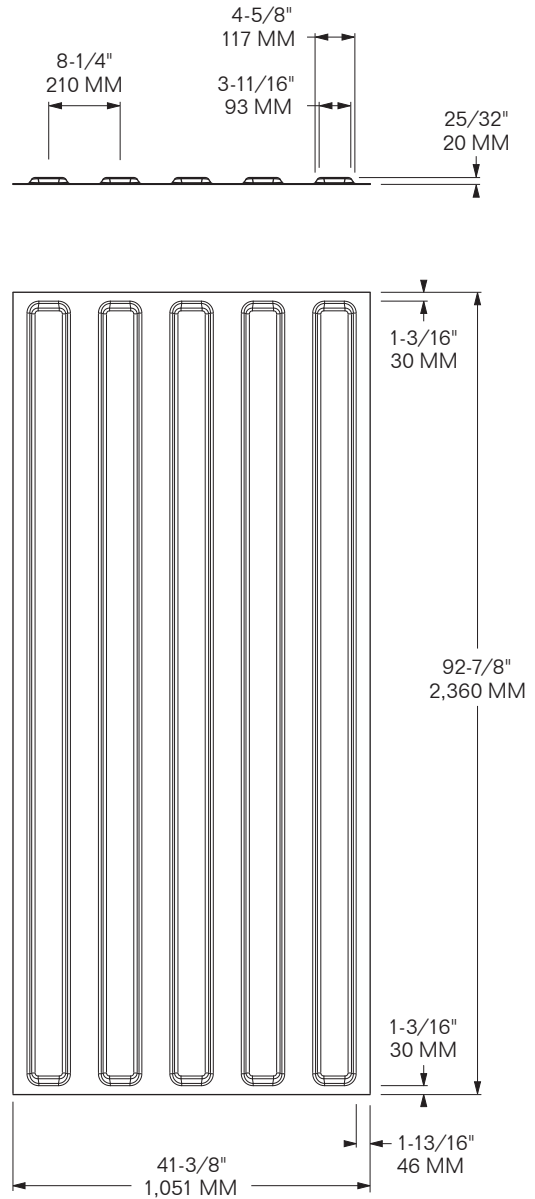

SUB FOR: SINGAMAS QPCL-50001
FITS: STANDARD 96" ISO **THICKNESS:** 5/64" / 2 MM
MATERIAL: CORTEN STEEL **FINISH:** PRIMER
WEIGHT: 91 LBS / 41.28 Kg

MODEL 1202-6104

for 45' x 96" ISO

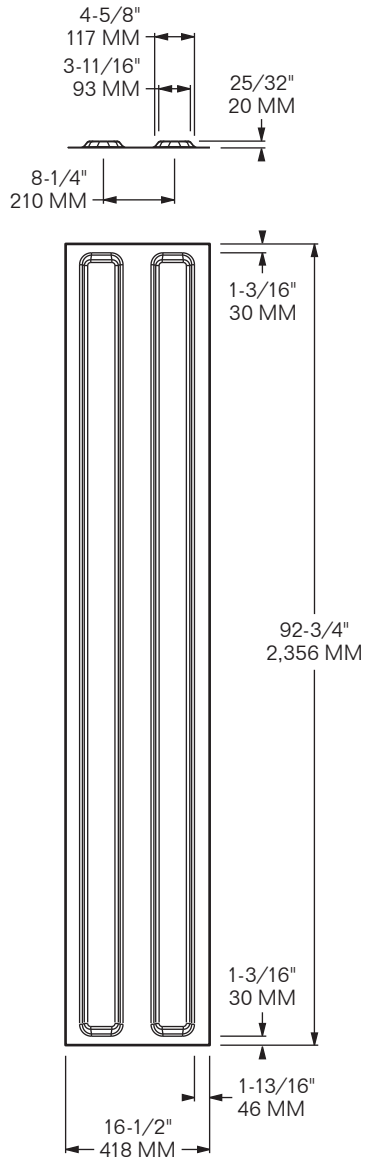

FITS: 45' x 96" ISO
WORKS WITH: BUFFERS 1202-2149
THICKNESS: 5/64" / 2 MM
MATERIAL: CORTEN STEEL **FINISH:** PRIMER
WEIGHT: 35 LBS / 15.88 Kg